



KELSEY-KANE LIGHTING MANUFACTURING COMPANY

"Serving Lighting Professionals Since 1978"

LED Low Pressure Sodium Replacement

AL35Q L70 25°C 246,000 Hours

HiLumen Amber 16" Area, Wall, and Flood Light



Shown with FLEM6 Accessory.

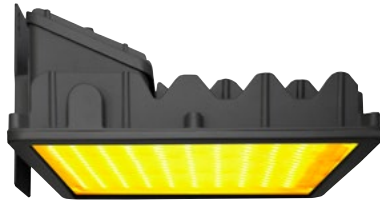

Shown with Wall Mount Option.



Shown with Slipfitter Option.

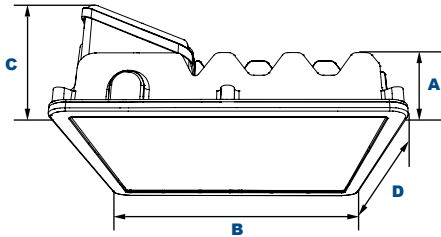

Dimensions		Length with Mount (L)	
Width (B)	16½" (419mm)	Bracket (BR): 21¾" (543mm)	
Length (D)	16½" (419mm)	Slipfitter (SF): 22¾" (557mm)	
Height (A)	3" (76mm)	Yoke (LY): 21½" (547mm)	
Height (C)	7" (178mm)	Mounting Arm Adaptor (MA): 21" (534mm)	
		Wall Mount Bracket (WM): 17½" (447mm)	

The AL35Q luminaire is available with a wide choice of mounting configurations designed to provide a direct 1-to-1 replacement for 90w Low Pressure Sodium (LPS) lighting systems. Typical applications include general area, parking, flood, security, and accent lighting for retail centers, industrial parks, schools and universities, public transit and airports, office buildings and medical facilities. Mounting heights of 16 to 25 feet can be used based on light level and uniformity requirements.

Specifications and Features:

Housing:

Heavy-Duty Die Cast Aluminum Housing & Front Frame, Integral Heat Sinking, Driver Compartment. Photocell Adaptable.

Listing & Ratings:

CSA: Listed for Wet Locations, ANSI/UL 1598, 8750; IP66 Sealed LED Compartment.

Finish:

Textured Architectural Bronze Powdercoat Finish Over a Chromate Conversion Coating. Custom Colors Available Upon Request.

Lens:

Tempered Clear Flat Glass Lens.

Mounting Options:

Mount with Two-Piece Swivel Bracket, Adjustable Slipfitter, Yoke, Mounting Arm Adaptor or Wall Mount Bracket.

HiLumen Amber LED:

Aluminum Boards

Wattage:

126w Array: 126w, System: 137.6w; (90w SOX LPS Replacement)

Driver:

Electronic Driver, 120-277V, 50/60Hz or 347-480V, 50/60Hz; Less Than 20% THD and PF>0.90. Standard Internal Surge Protection 6kV. 0-10V Dimming Standard for a Dimming Range of 100% to 10%; Dimming Source Current is 150 Microamps.

Controls:

Fixtures Ordered with Factory-Installed Photocell or Motion Sensor Controls are Internally Wired for Switching and/or 1-10V Dimming Within the Housing. Remote Direct Wired Interface of 1-10V Dimming is Not Implied and May Not Be Available, Please Consult Factory. Fixtures are Tested with LEPC Controls and May Not Function Properly With Controls Supplied By Others. Fixtures are NOT Designed for Use with Line Voltage Dimmers.

Warranty:

5-Year Warranty for -40°C to +50°C Environment.

See Page 3 for Projected Lumen Maintenance Table.

Order Information Example: AL35QF1X126UHACZBRSP

AL35Q	F	1X126		HA	C			
Model	Optics/Beam	Wattage	Driver	CCT	Lens	Color	Mounting	Options
AL35Q=HiLumen Amber 16" Area, Flood and Wall Light	F=Type V/NEMA 7H x 7V See Page 3 for Distribution Information.	1X126=126w	U=120-277V H=347-480V	HA=HiLumen Amber	C=Clear Flat Glass Lens	Z=Bronze C=Custom (Consult Factory)	BR=Two-Piece Swivel Bracket SF=Slipfitter LY=Large Yoke MA=Mounting Arm Adaptor WM=Wall Mount Bracket NM=No Mount	SF=Single Fuse (120-277V Only) DF=Double Fuse (120-277V Only) SP=Surge Protection R3=3-Pin Twist Lock Photocell Receptacle R5=5-Pin Twist Lock Photocell Receptacle R7=7-Pin ANSI C136.41—2013 Twist Lock Photocell Receptacle

Project Information:

Project Name: _____ Fixture Type: _____

Complete Catalog #: _____ Date: _____

Comments: _____

Certification & Listings:



Specifications subject to change without notice. Rev. 010820



KELSEY-KANE LIGHTING MANUFACTURING COMPANY

"Serving Lighting Professionals Since 1978"

AL35Q

L70
25°C

246,000 Hours

HiLumen Amber 16" Area, Wall, and Flood Light

Mounting Options:



AL35Q with Two-Piece Swivel Bracket (BR)

Two-Piece Stamped Steel Adjustable Bracket, Bronze Powdercoat Finish, Includes Hardware.



AL35Q with External Slipfitter (SF)

External Mount Die-Cast Adjustable Slipfitter for 2 3/4" Tenons, Bronze Powdercoat Finish, Includes Hardware.



AL35Q with Yoke (Y)

Stamped Heavy-Duty Steel, Bronze Powdercoat Finish.



AL35Q with Pole Mounting Arm Adaptor (MA)

Fits 2 3/4" Arm, Includes Hardware, Bronze Powdercoat Finish.





AL35Q with Wall Mount Bracket (WM)



Wall Bracket, Heavy-Duty Stamped Steel, Bronze Powdercoat Finish, Includes Hardware.

EPA (Effective Projected Area)

Shown with FLEM6 mounting.

Configuration	EPA (Sq. Ft.)	Weight (Lbs.)
 1	.66	29 Lbs

Configuration	EPA (Sq. Ft.)	Weight (Lbs.)
 2@180 Mount	1.32	58 Lbs
 2@90 Mount	.90	58 Lbs

Configuration	EPA (Sq. Ft.)	Weight (Lbs.)
 3@90 Mount	1.45	87 Lbs
 3@120 Mount	1.36	87 Lbs

Configuration	EPA (Sq. Ft.)	Weight (Lbs.)
 4@90 Mount	1.45	116 Lbs

Accessories & Replacement Parts:



Mounting Accessories (Order Separately, Field Installed)	
PTASUNVZ	Square Pole Tenon Adaptor Allows Installation of Up to 4 Fixtures, Fits 2 3/4" Vertical Tenon, Bronze Powdercoat Finish. Use with Extruded Mounting Arms.
FLEMWMZ	Stamped Heavy-Duty Steel Wall Bracket for Extruded Mounting Arms, Bronze Powdercoat Finish.
PTSB1SZ	Single Pole Tenon Spoke Bracket, 2 3/4" Horizontal Mounting Arm, Bronze Powdercoat Finish, Includes Hardware.
PTSB290SZ	Twin Pole Tenon Spoke Bracket, 2 3/4" Horizontal 90° Mounting Arms, Bronze Powdercoat Finish, Includes Hardware.
PTSB2180SZ	Twin Pole Tenon Spoke Bracket, 2 3/4" Horizontal 180° Mounting Arms, Bronze Powdercoat Finish, Includes Hardware.
PTSB390SZ*	Triple Pole Tenon Spoke Bracket, 2 3/4" Horizontal 90° Mounting Arms, Bronze Powdercoat Finish, Includes Hardware.
PTSB3120SZ*	Triple Pole Tenon Spoke Bracket, 2 3/4" Horizontal 120° Mounting Arms, Bronze Powdercoat Finish, Includes Hardware.
PTSB490SZ*	Quad Pole Tenon Spoke Bracket, 2 3/4" Horizontal 90° Mounting Arms, Bronze Powdercoat Finish, Includes Hardware.
FLEM6Z	6" Extruded Aluminum Mounting Arm, Bronze Powdercoat Finish, Includes Hardware. Fits Square Poles. Mounts at 3° tilt.
FLEM10Z	10" Extruded Aluminum Mounting Arm, Bronze Powdercoat Finish, Includes Hardware. Fits Square Poles. Mounts at 3° tilt.
FLEM12Z	12" Extruded Aluminum Mounting Arm, Bronze Powdercoat Finish, Includes Hardware. Fits Square Poles. Mounts at 3° tilt.

◊Add R for Round Pole Mounting, Fits 4" & 5" Diameter Poles.

***Non-stock item. Consult factory for lead time.**

Accessories (Order Separately, Field Installed)	
P18131	Twist Lock Non-Shorting (Open) Cap Disconnects Service to Fixture for Temporary or Permanent Disabling (Fixture Always Off). IP65, 480V Maximum.
P18132	Twist Lock Shorting Cap Provides Fixed Service to Fixture (Fixture Always on). IP65, Rated Load 7200w Tungsten.
P18140	110-120VAC Instant Twist Lock Photocell
P18150	120VAC Time Delay Twist Lock Photocell
P18152	277VAC Time Delay Twist Lock Photocell
P18156	120-277VAC Universal Twist Lock Photocell
P18157	480VAC Time Delay Twist Lock Photocell. For 480V use only.
AL35GSZ	Aluminum Glare/House Side Shield, Bronze Powdercoat Finish, Includes Hardware.
AL35WG	Wire Guard, Stainless Steel Construction, Includes Hardware.

Replacement Parts (Order Separately, Field Installed)	
AL35GL	Tempered Clear Flat Glass Lens.
FL73BRZ	Two-Piece Stamped Steel Adjustable Bracket, Bronze Powdercoat Finish, Includes Hardware.
AL35YZ	Stamped Heavy-Duty Steel Yoke, Bronze Powdercoat Finish, Includes Hardware.
FL73SFXZ	External Mount Die-Cast Adjustable Slipfitter for 2 3/4" Tenons, Bronze Powdercoat Finish, Includes Hardware.
ALMAAZ	Die-Cast Adaptor for 2 3/4" Horizontal Mounting Arms, Bronze Powdercoat Finish, Includes Hardware.
WBR2Z	Wall Bracket, Heavy-Duty Stamped Steel, Bronze Powdercoat Finish, Includes Hardware.

Specifications subject to change without notice. Rev. 010820



Photometric Data

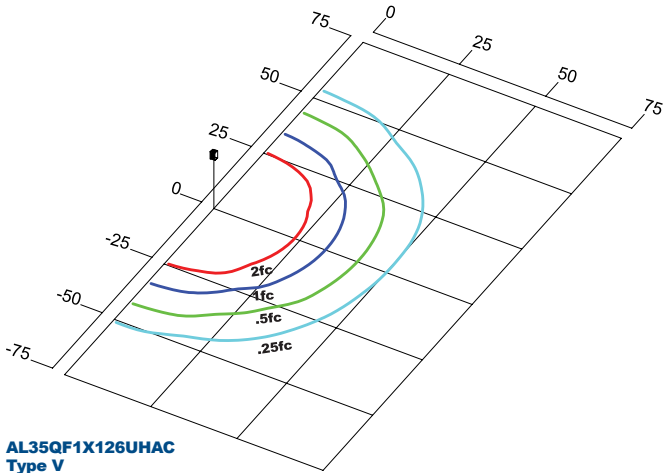

AL35QF1X126UHAC
Type V
 Grid in MH
 MH=25 Feet

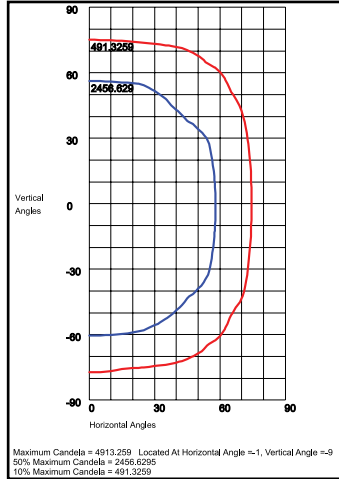

AL35QF1X126UHAC
120°H x 120°V, NEMA 7H x 7V

Spectral Chart

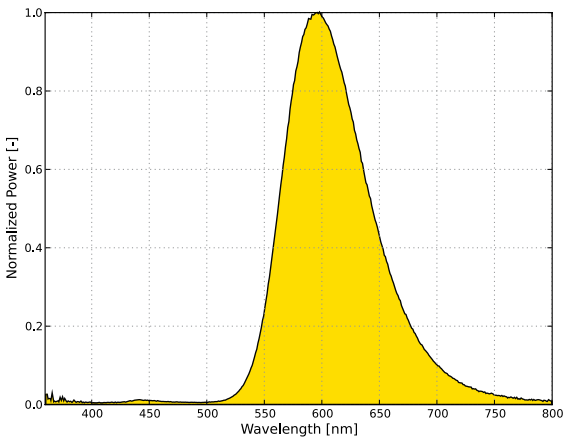

Photometric Performance

LED Board Watts	Input Watts	Optics	HiLumen Amber				
			Lumens	LPW	B	U	G
HiLumen Amber 126w	138	F Type V	14,573	106	3	0	1

LED Board Watts	Input Watts	Optics	HiLumen Amber	
			Lumens	LPW
HiLumen Amber 126w	138	F 120°H x 120°V, NEMA 7H x 7V	14,534	104

Projected Lumen Maintenance

Data shown for HiLumen Amber	Compare to LPS					
	TM-21-11	Input Watts	Initial	25,000 Hrs	50,000 Hrs	100,000 Hrs
L70 Lumen Maintenance @ 25°C / 77°F	138	1.00	0.97	0.94	0.88	246,000

- NOTES:**
1. Projected per IESNA TM-21-11. Data references the extrapolated performance projections for the base model in a 25°C ambient, based on 10,000 hours of LED testing per IESNA LM-80-08.
 2. Compare to LPS box indicates suggested Light Loss Factor (LLF) to be used when comparing to Low Pressure Sodium (LPS) systems