

Induction Light Series

Induction High Bay



HB111
Shown with 22" Refractor
(Not Included)

Housing:

Heavy Duty Die Cast Aluminum Housing, White Powdercoat Finish Over a Chromate Conversion Coating, Electrical Box with Malleable Hook.

Reflector:

22" Prismatic Acrylic Refractor, Spun Aluminum Reflector, or Faceted Aluminum Reflector. (Sold Separately; Required)

Lens:

Clear Flat Glass Lens, Acrylic Drop or Conical Lenses; Glass Lens Cannot Be Used with Acrylic Refractors. (Sold Separately).

Mounting:

Mount on 3/4" Malleable Hook (Included) or Downrod.

Wattage:

Induction: 80, 100 or 120w, 5000K

Listing & Ratings:

CSA: Listed for Dry Locations

Options:

2.5KV Surge Protection

Custom Colors Available Upon Request.

Complete Units (Includes Lamp & Ballast)				
Catalog #	Wattage	Voltage	Lamp	Ballast
HB11180U5K*	80	120-277	Induction	Electronic
HB111100U5K*	100	120-277	Induction	Electronic
HB111120U5K*	120	120-277	Induction	Electronic

*Specify Optics: C22=Acrylic Refractor, R22=Spun Aluminium Reflector, F22=Faceted Aluminum Reflector

- Add SP for Surge Protection

KELSEY-KANE LIGHTING MFG. CO.
Voice & Text: 954-772-3187
E-Mail: info@kelsey-kane.com
Website: www.kelsey-kane.com

DIMENSIONS

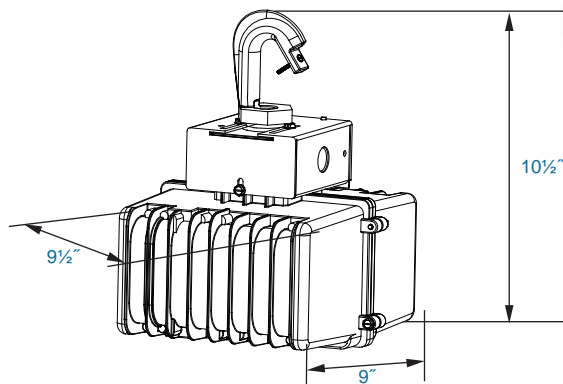

HB111

Catalog #	Description
HBACR22	22" LexaLite Clear Prismatic Acrylic Refractor for Applications Where High Vertical Illumination is Desired.
HB11AR22*	22" Reflector
*White reflectors - add W to end of above part numbers	
HBARF22	22" Faceted Reflector
HBARF22GL	22" Hinged Glass Lens for HBARF22
HBDL22	22" LexaLite Clear Prismatic Acrylic Drop Lens for Low and Medium Bay Applications. UV Stabilized, High-Efficiency Operation in General Applications.
HBCL22	22" LexaLite Clear Prismatic Acrylic Conical Lens for Low and Medium Bay Applications. Lifts the Main Beam and Breaks up the Lamp Image.
HBGL22	22" Flat Glass. (Glass Lens Cannot Be Used with Acrylic Refractors.)
HBCB22	22" Clampband
HB11CO22	Collar for 22" Acrylic Refractors, White
HBARF22WG	Wire Guard for 22" Faceted Reflector
HBAR22WG	Wire Guard for 22" Aluminum and 22" Aluminum Low-Profile Reflectors
CPMH1	Malleable Hook with 3/4" NPS Threads
CPSP#	Swivel Pendant Mount for Angled or Straight Ceilings, Fits 3/4" Conduit, Includes Reducer Bushing (to 1/2") & Set Screw
# Specify Mount: R=Round Swivel Mount, S=Square Swivel Mount	
CPCS1633	Cord Set, Blunt Cut, 3', 16/3 600V STW cord
CPCS1633P110	Cord Set, 3-Prong Polarized, 3' Cord
CPCS1633P120	Cord Set 120v Twist-Lock L5-15P Plug, 3' Cord
CPCS1633P240	Cord Set 240v Twist-Lock L6-15P Plug, 3' Cord
CPCS1633P277	Cord Set 277v Twist-Lock L7-15P Plug, 3' Cord

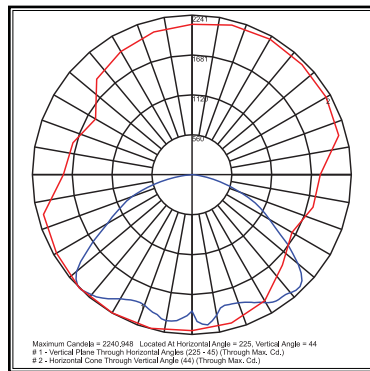

HB11120AR22

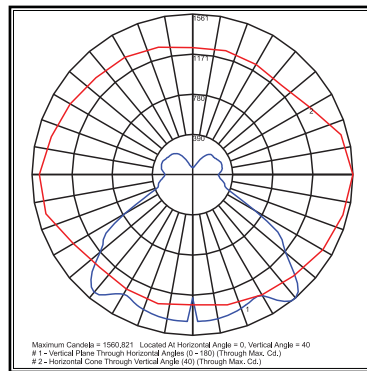

HB11120AC22

Induction Light Series

Induction High Bay



HBACR22



HB11AR22



White Reflector



HBARF22 & HBARF22GL



HBDL22



HBCL22



HBGL22



HBCB22

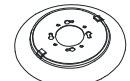

HB11CO22

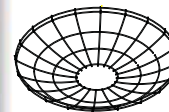

HBARF22WG



HBAR22WG



CPMH1



CPSPR

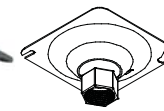

CPSPS



CPCS1633

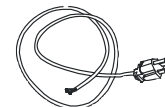

CPCS1633P110



CPCS1633P120

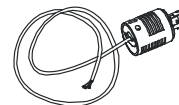

CPCS1633P240



CPCS1633P277

KELSEY-KANE LIGHTING MFG. CO.
 Voice & Text: 954-772-3187
 E-Mail: info@kelsey-kane.com
 Website: www.kelsey-kane.com