

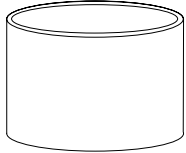

PSRA

Straight Round Aluminum Poles, 4", 5"



4" and 5" Round

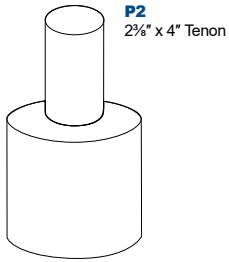

P2
2 1/2" x 4" Tenon

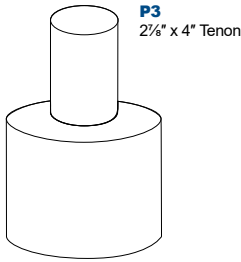

P3
2 1/2" x 4" Tenon

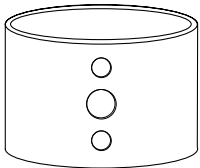

Side Drills:
2 at 180°, 4 at 90°



10-25 Feet

PSRA Series Straight Round Aluminum poles are built from extruded aluminum tube with high-strength die cast aluminum base and are available side drilled for arm mounted area lighting luminaires or with tenon mounts for flood and post top luminaires. Typical area lighting applications include retail centers, industrial parks, schools and universities, public transit and airports, office buildings and medical facilities. Mounting heights of 10 to 25 feet can be used based on selected luminaire application.

Specifications and Features:

Pole Specifications:

The Pole Shaft is of Uniform Wall Thickness and is One-Piece Extruded 6063 Aluminum Alloy With T6 Temper, Available in 4" and 5" Diameters. Anchor Base is Die Cast From 356 Alloy Aluminum and is Heat Treated to a T6 Temper After Welding. Wall Thickness: 5mm (.196").

Finish:

Textured Architectural Black Powdercoat Finish, Baked to Ensure Maximum Paint Adhesion, Hardness and Durability.

Anchor Bolts:

Anchor Bolts are Included, Sized Based on Pole Data Charts for the Selected Pole Size.

Hand Hole:

Die Cast Aluminum Reinforced Hand Hole and Cover with Ground Screw.

Base Cover

Poles are Provided with a Two-Piece Formed Aluminum Base Cover that is Easily Assembled and Fitted Over Pole Base.

Mounting Options:

Available Side Drilled for 2@180 Degrees or 4@90 Degrees, Includes Polycarbonate Top Cover and Hole Plugs for Unused Drilling Locations.

Poles May Also Be Ordered With 2 1/2" OD or 2 3/8" OD Tenons for Use With Post Top Decorative Luminaires, Flood/Area Slip Fitter Fixtures, or Any of a Wide Variety of Pole Top Mounting Accessories.

Order Information Example:

PSRA2555BP3ELBC

PSRA	Height/Shaft/Gauge (Pick one)		B	Pole Top Mounting	Drill Template	Options
Model	4" Round 5mm Wall	5" Round 5mm Wall	Color			
PSRA= Straight Round Aluminum Pole	1045=10' 1245=12' 1445=14' 1645=16' 1845=18' 2045=20'	1655=16' 1855=18' 2055=20' 2555=25'	B=Black	D2=Drilled 2 Sides at 180 with Plugs (1) D4=Drilled 4 Sides with Plugs (1) P2=2 1/2" x 4" H Tenon P3=2 1/2" x 4" H Tenon	(Leave Blank)=Poles with P2 or P3 Tenon S=Standard Arm/Accessories D=Kitty Hawk Arm KH25, KH20 E=Kitty Hawk Arm KH45 C=Custom (Specify)	(Leave Blank)=No Options LAB=Less Anchor Bolts (2) LBC=Less Base Cover (3)

Project Information:

Project Name: _____ Fixture Type: _____

Complete Catalog #: _____ Date: _____

Comments: _____

Notes:

- Side Drilled poles include polycarbonate pole cap.
- All poles include anchor bolts standard, consult dimension table for size based on pole dimensions.
- All poles include square 2-piece black base cover.



Wind Loading and Dimensional Data:

Pole Description		80 MPH		90 MPH		100 MPH		110 MPH		120 MPH		130 MPH		140 MPH		150 MPH		Structure Weight (LBS)
Shaft Size & Wall Thickness	Mounting Height	Max EPA (SQ FT)	Max Weight (LBS)	Max EPA (SQ FT)	Max Weight (LBS)	Max EPA (SQ FT)	Max Weight (LBS)	Max EPA (SQ FT)	Max Weight (LBS)	Max EPA (SQ FT)	Max Weight (LBS)	Max EPA (SQ FT)	Max Weight (LBS)	Max EPA (SQ FT)	Max Weight (LBS)	Max EPA (SQ FT)	Max Weight (LBS)	
4" Round, 5mm Wall	10' - 0"	16.3	175	12.0	100	9.4	100	7.6	100	6.3	100	5.3	100	4.5	100	3.9	100	43
	12' - 0"	12.1	185	9.6	100	7.4	100	5.9	100	4.9	100	4.1	100	3.5	100	2.9	100	52
	14' - 0"	9.7	190	7.7	100	5.8	100	4.6	100	3.7	100	3.1	100	2.6	100	2.2	100	60
	16' - 0"	7.5	155	6.0	100	4.4	100	3.3	100	2.7	100	2.2	100	1.8	100	1.5	100	69
	18' - 0"	5.7	125	4.6	100	3.1	100	2.3	100	1.8	100	1.4	100	1.1	100	0.9	100	78
	20' - 0"	4.3	95	3.3	100	2.1	100	1.4	100	1.0	100	0.7	100	0.5	100	-	-	86
5" Round, 5mm Wall	16' - 0"	10.1	200	8.6	100	6.6	100	5.3	100	4.4	100	3.6	100	3.0	100	2.5	100	72
	18' - 0"	8.0	255	6.8	100	5.1	100	4.1	100	3.3	100	2.7	100	2.2	100	1.8	100	81
	20' - 0"	6.4	150	5.2	100	3.8	100	3.0	100	2.3	100	1.9	100	1.5	100	1.2	100	90
	25' - 0"	4.0	200	3.4	100	2.4	100	1.7	100	1.2	100	0.8	100	0.6	100	-	-	112

- NOTES:**
1. Maximum EPA (Effective Projected Area) and weight values are based on AASHTO 2013 (90-150MPH) and AASHTO 2008 (80MPH).
 2. Consult factory on loading criteria for pole top mounted luminaires and/or brackets.
 3. Variations from sizes above are available upon inquiry at the factory.
 4. Satisfactory performance of poles is dependent upon the pole being properly attached to a supporting foundation of adequate design.
 5. Structure weight is a nominal value which includes the pole shaft and base plate only.

Pole Data:

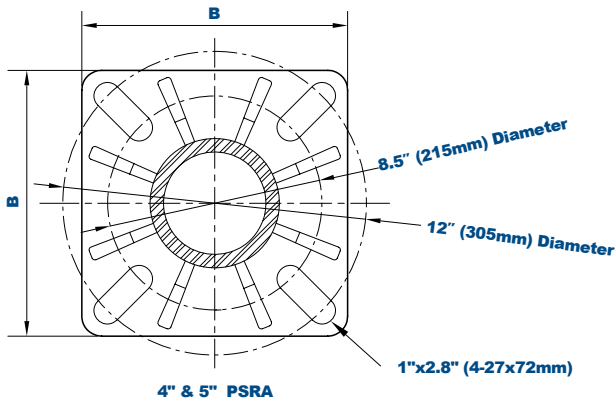

Shaft Base Size	Bolt Circle A	Base Size B	Base Thickness C	Bolt Projection	Anchor Bolt Size
4" PSRA	8.5"-12" (215-305mm)	10.5" (267mm)	1"	4"	M20 x 27½"
5" PSRA	8.5"-12" (215-305mm)	10.5" (267mm)	1"	4"	M20 x 27½"

Pole Top Mounting:

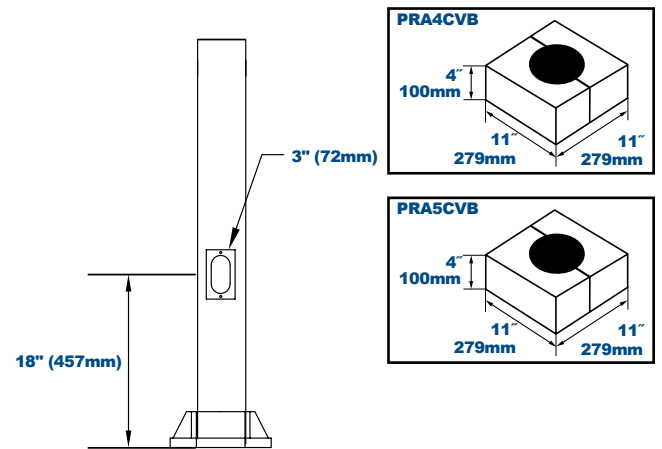
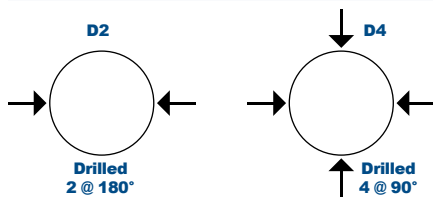

Specifications subject to change without notice. Rev. 073117



4" and 5" Straight Round Aluminum Pole Mounting Options

Order separately, field installed.

Spoke Brackets:

Bronze Finish, Spoke Bracket have 6 1/2" Arms. Fit 2 3/8" (P2) Tenons.



Single Spoke Bracket
PTSB1SZ



Twin Spoke Bracket,
90° Arms
PTSB290SZ



Twin Spoke Bracket,
180° Arms
PTSB2180SZ



Triple Spoke Bracket,
90° Arms
PTSB390SZ*

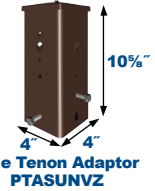

Pole Tenon Adaptor
PTASUNVZ



Triple Spoke Bracket,
120° Arms
PTSB3120SZ*



Quad Spoke Bracket,
90° Arms
PTSB490SZ*

*Special Order Item. Lead Time Three Weeks.

4" & 5" Vertical Tenon Pole Top Fitters:

Black Finish

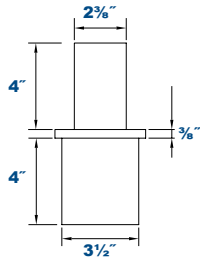

2 3/8" Single Round
Vertical Tenon (P2)
PSRA42B

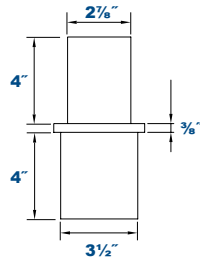

2 3/8" Single Round
Vertical Tenon (P3)
PSRA43B

Fits 4" PRSA Poles

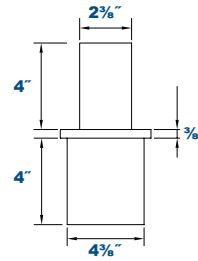

2 3/8" Single Round
Vertical Tenon (P2)
PSRA52B

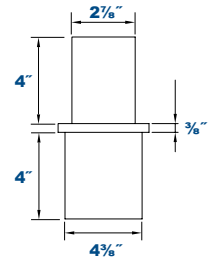

2 3/8" Single Round
Vertical Tenon (P3)
PSRA53B

Fits 5" PRSA Poles

Wall Mounting Bracket:

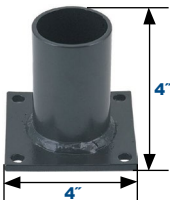

Wall Mount
Bracket
PRSWMBZ

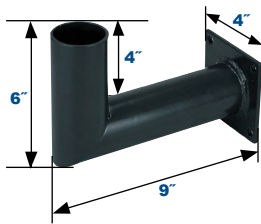

Wall Mount 90°
Bracket
PRSWMB90Z

Replacement Parts:



PRA4CVB,
PRA5CVB

**Replacement Parts
(Order separately, Field installed)**

PRA4CVB Base Cover for 4" Pole, Black Finish

PRA5CVB Base Cover for 5" Pole, Black Finish

PAB34X30 M20 x 27 1/2" Anchor Bolts, Set of 4