

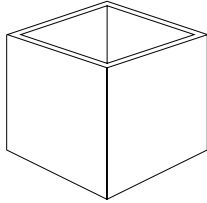

PSSS

Straight Square Steel Poles, 4", 5"



4" and 5" Square

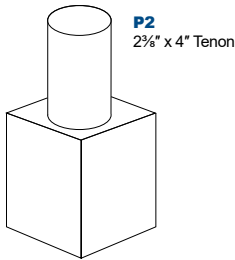

P2
2 1/2" x 4" Tenon

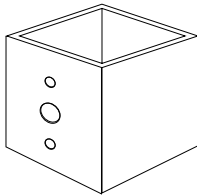

Side Drills:
2 at 180°, 4 at 90°

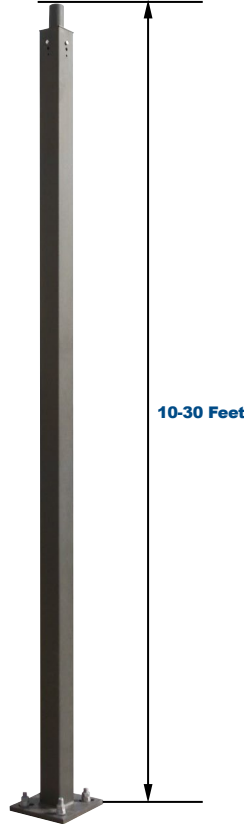

10-30 Feet

PSSS Series Straight Square Steel poles are built from high strength steel tube and are available side drilled for arm mounted area lighting luminaires or with tenon mounts for flood and post top luminaires. Typical area lighting applications include retail centers, industrial parks, schools and universities, public transit and airports, office buildings and medical facilities. Mounting heights of 10 to 30 feet can be used based on selected luminaire application.

Specifications and Features:

Pole Specifications:

Conforms to ASTM-A 500 Grade B: Minimum Yield Strength of 46,000 PSI. Wall Thickness Available in 11 Gauge (.120") or 7 Gauge (.180").

Finish:

Textured Architectural Bronze Powdercoat Finish, Baked to Ensure Maximum Paint Adhesion, Hardness and Durability.

Anchor Bolts:

Anchor Bolts are Included, Sized Based on Pole Data Charts for the Selected Pole Size.

Hand Hole:

Cast Iron Reinforced Hand Hole and Cover with Ground Screw.

Base Cover:

Poles are Provided With a Two-Piece Formed Steel Base Cover that is Easily Assembled and Fitted Over Pole Base.

Mounting Options:

Available Side Drilled for 2@180 Degrees or 4@90 Degrees, Includes Polycarbonate Top Cover and Hole Plugs for Unused Drilling Locations.

Poles May Also Be Ordered With 2 1/2" OD Tenons for Use With Post Top Decorative Luminaires, Flood/Area Slip Fitter Fixtures, or Any of a Wide Variety of Pole Top Mounting Accessories.

Order Information Example:

PSSS30507ZP2ELBC

PSSS			Z				
Model	Height/Shaft/Gauge (Pick One)			Color	Pole Top Mounting	Drill Template	Options
	4" Square 11 Gauge:	4" Square 7 Gauge:	5" Square 7 Gauge:				
PSSS=Straight Square Steel Pole	10411=10' 12411=12' 14411=14' 16411=16' 18411=18' 20411=20'	10407=10' 12407=12' 14407=14' 16407=16' 18407=18' 20407=20' 25407=25'	10507=10' 12507=12' 14507=14' 16507=16' 18507=18' 20507=20' 22507=22' 25507=25' 28507=28' 30507=30'	Z=Bronze	D2=Drilled 2 Sides at 180° with Plugs (1) D4=Drilled 4 Sides with Plugs (1) P2=2 1/2" x 4" H Tenon	(Leave Blank)=Poles with P2 Tenon S=Standard Arm/Accessories D=Kitty Hawk Arm KH25, KH20 E=Kitty Hawk Arm KH45 C=Custom (Specify)	(Leave Blank)=No Options LAB=Less Anchor Bolts (2) LBC=Less Base Cover (3)

Project Information:

Project Name: _____ Fixture Type: _____

Complete Catalog #: _____ Date: _____

Comments: _____

Notes:

- Side Drilled poles include polycarbonate pole cap.
- All poles include anchor bolts standard, consult dimension table for size based on pole dimensions.
- All poles include square 2-piece bronze base cover.



Wind Loading and Dimensional Data:

Pole Description		80 MPH		90 MPH		100 MPH		110 MPH		120 MPH		130 MPH		140 MPH		150 MPH		Structure Weight (lbs.)
Shaft Size & Wall Thickness	Mounting Height	Max EPA (SQ FT)	Max Weight (LBS)	Max EPA (SQ FT)	Max Weight (LBS)	Max EPA (SQ FT)	Max Weight (LBS)	Max EPA (SQ FT)	Max Weight (LBS)	Max EPA (SQ FT)	Max Weight (LBS)	Max EPA (SQ FT)	Max Weight (LBS)	Max EPA (SQ FT)	Max Weight (LBS)	Max EPA (SQ FT)	Max Weight (LBS)	
4" Square, 11 Gauge	10' - 0"	30.6	765	20.0	500.0	16.0	400.0	13.0	325.0	10.5	263.0	8.5	213.0	7.0	175.0	6.0	150.0	73
	12' - 0"	24.4	610	16.0	400.0	13.0	325.0	10.0	250.0	8.0	200.0	6.5	163.0	5.0	125.0	4.0	100.0	88
	14' - 0"	19.9	498	13.5	338.0	10.0	250.0	7.5	188.0	6.0	150.0	4.5	113.0	3.5	88.0	2.5	63.0	102
	16' - 0"	15.9	398	10.5	263.0	7.5	188.0	5.5	138.0	4.0	100.0	3.0	75.0	1.5	38.0	1.0	25.0	117
	18' - 0"	12.6	315	8.0	200.0	5.5	138.0	4.0	100.0	2.5	63.0	1.5	38.0	0.5	13.0	-	-	131
	20' - 0"	9.6	240	6.0	150.0	4.0	100.0	2.5	63.0	1.0	25.0	-	-	-	-	-	-	146
4" Square, 7 Gauge	10' - 0"	32.3	807	27.3	681.4	19.9	499.0	14.7	366.9	10.5	262.1	7.3	184.5	5.2	132.1	3.1	79.7	102
	12' - 0"	24.8	621	21.0	524.2	15.3	383.8	11.3	282.2	8.1	201.6	5.6	141.9	4.0	101.6	2.4	61.3	123
	14' - 0"	20.7	517	17.5	436.8	12.8	319.9	9.4	235.2	6.7	168.0	4.7	118.3	3.4	84.7	2.0	51.1	143
	16' - 0"	17.2	431	14.6	364.0	10.6	266.6	7.8	196.0	5.6	140.0	3.9	98.6	2.8	70.6	1.7	42.6	164
	18' - 0"	15.4	385	13.0	325.0	9.5	238.0	7.0	175.0	5.0	125.0	3.5	88.0	2.5	63.0	1.5	38.0	184
	20' - 0"	14	350	10.5	263.0	7.5	188.0	5.5	138.0	3.5	88.0	2.0	50.0	1.0	25.0	-	-	205
5" Square, 7 Gauge	10' - 0"	64.8	1621	46.1	1153	35	865	27	664	20	491	14	346	10	261	7	173	135
	12' - 0"	49.9	1247	35.5	887	27	665	20	511	15	378	11	266	8	200	5	133	162
	14' - 0"	41.5	1039	29.6	739	22	554	17	426	13	315	9	222	7	167	4	111	189
	16' - 0"	34.6	866	24.6	616	18	462	14	355	10	262	7	185	6	139	4	92	217
	18' - 0"	30.9	773	22	550	17	413	13	317	9	234	7	165	5	124	3	83	244
	20' - 0"	28.1	703	20.0	500	15	375	12	288	9	213	6	150	5	113	3	75	271
	22' - 0"	24.1	602	16.2	405	13	320	8	207	5	113	2	57	2	57	2	38	298
	25' - 0"	18.5	463	12.0	300	9	213	6	138	3	75	2	38	-	-	-	-	338
	28' - 0"	13.9	347	8.8	220	5	132	2	38	-	-	-	-	-	-	-	-	379
	30' - 0"	10.7	267	6.5	163	4	88	1	25	-	-	-	-	-	-	-	-	406

- NOTES:**
1. Maximum EPA (Effective Projected Area) and weight values are based on AASHTO 2013 (90-150MPH) and AASHTO 2008 (80MPH).
 2. Consult factory on loading criteria for pole top mounted luminaires and/or brackets.
 3. Variations from sizes above are available upon inquiry at the factory.
 4. Satisfactory performance of poles is dependent upon the pole being properly attached to a supporting foundation of adequate design.
 5. Structure weight is a nominal value which includes the pole shaft and base plate only.

Pole Data:

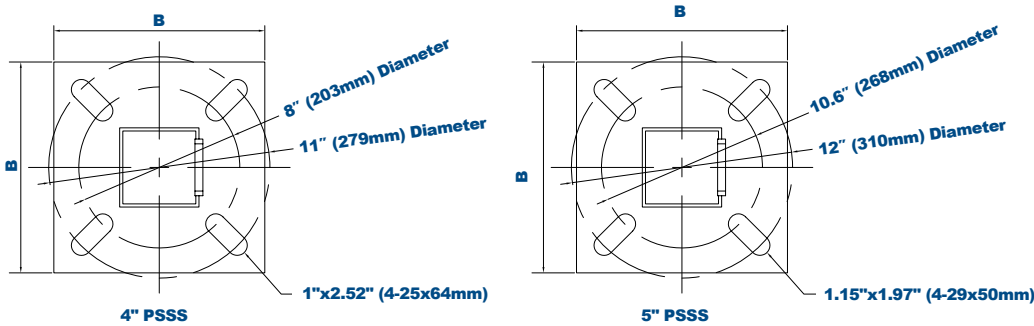

Shaft Base Size	Bolt Circle A	Base Size B	Base Thickness C	Bolt Projection	Anchor Bolt Size
4" PSSS	8"-11" (203-279mm)	10.5" (266mm)	¾"	4"	M20 x 27½"
5" PSSS	10.6"-12" (268-310mm)	11" (280mm)	1"	4"	M22 x 33"

Pole Top Mounting:

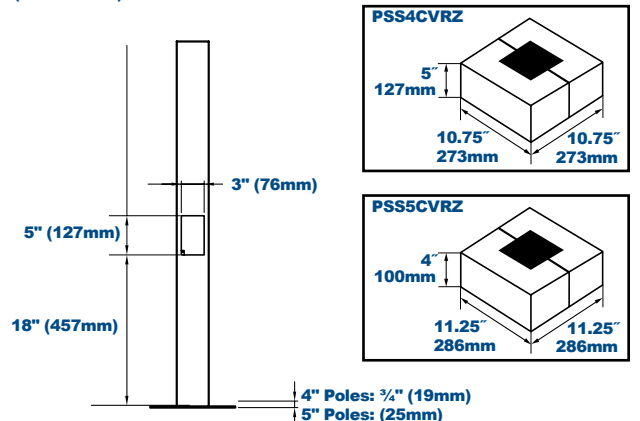
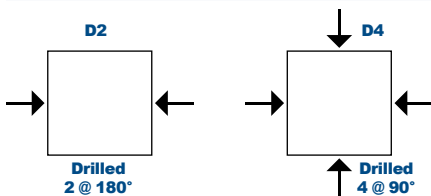

Specifications subject to change without notice. Rev. 073117



4" Straight Square Steel Pole Mounting Options

Order separately, field installed.

Spoke Brackets and Bullhorns:

Bronze Finish, Spoke Bracket have 6 1/2" Arms. Fit 2 3/8" (P2) Tenons.



Single Spoke Bracket
PTSB1SZ



Twin Spoke Bracket,
90° Arms
PTSB290SZ



Twin Spoke Bracket,
180° Arms
PTSB2180SZ



Triple Spoke Bracket,
90° Arms
PTSB390SZ*

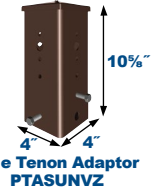

Pole Tenon Adaptor
PTASUNVZ



Triple Spoke Bracket,
120° Arms
PTSB3120SZ*



Quad Spoke Bracket,
90° Arms
PTSB490SZ*



180° Double Bullhorn
PRSD180BHZ

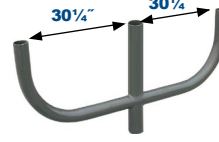

180° Triple Bullhorn
ECPRSTR180BHZ

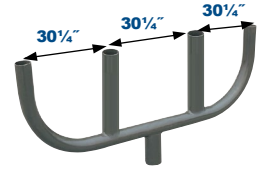

180° Quad Bullhorn
PRSQ180BHZ

*Special Order Item. Lead Time Three Weeks.

Vertical Tenon Pole Top Fitters:

4" Vertical Tenons, Bronze Finish, Fit 2 3/8" (P2) Tenons

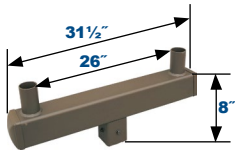

4" Twin Square
Vertical Tenon
PSS4TVTZ

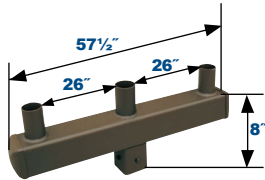

4" Triple Square
Vertical Tenon
PSS4TRVTZ

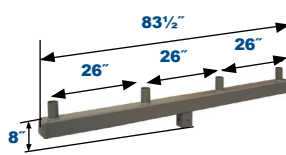

4" 180° Quad Square
Vertical Tenon
PSS4Q180VTZ

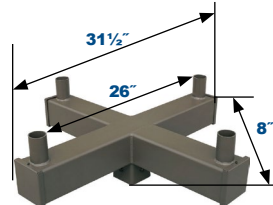

4" 90° Quad Square
Vertical Tenon
PSS4Q90VTZ

Vertical Tenon Pole Fitter:

Bronze Finish

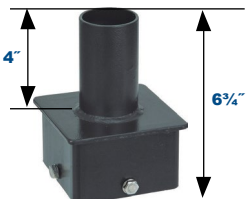

4" Single Square
Vertical Tenon
PSS4SVTZ

Horizontal Tenon Pole Fitters:

4" Tenons, Bronze Finish

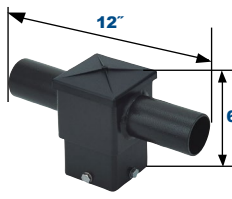

4" 180° Twin Square
Horizontal Tenon
PSS4T180HTZ

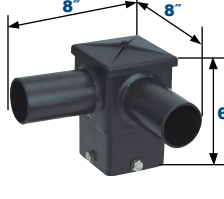

4" 90° Twin Square
Horizontal Tenon
PSS4T90HTZ

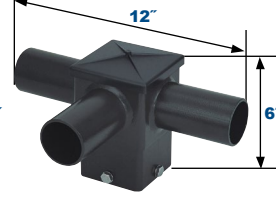

4" 90° Triple Square
Horizontal Tenon
PSS4TR90HTZ

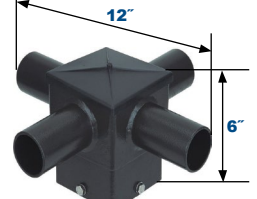

4" 90° Quad Square
Horizontal Tenon
PSS4Q90HTZ

Wall Mounting Bracket:

Bronze Finish

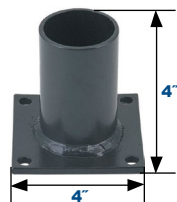

Wall Mount
Bracket
PRSWMBZ

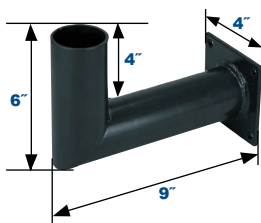

Wall Mount 90°
Bracket
PRSWMB90Z

Replacement Parts:



PSS4CZ



PSS4CVRZ



PSSHHC

**Replacement Parts
(Order separately, Field installed)**

PSS4CZ	4" Polycarbonate Pole Cap
PSS4CVRZ	Base Cover, Bronze Finish
PAB34X30	M20 x 27 1/2" Anchor Bolts, Set of 4
PSSHHC	Hand Hole Cover, Bronze Finish



5" Straight Square Steel Pole Mounting Options

Order separately, field installed.

Spoke Brackets and Bullhorns:

Bronze Finish, Spoke Bracket have 6 1/2" Arms. Fit 2 3/8" (P2) Tenons.

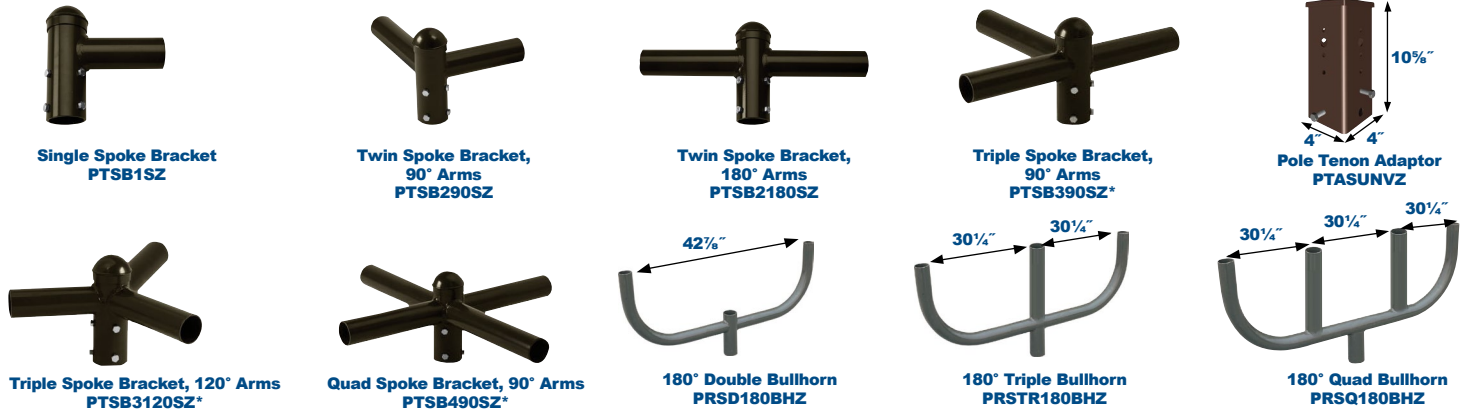

*Special Order Item. Lead Time Three Weeks.

Vertical Tenon Pole Top Fitters:

4" Vertical Tenons, Bronze Finish, Fit 2 3/8" (P2) Tenons

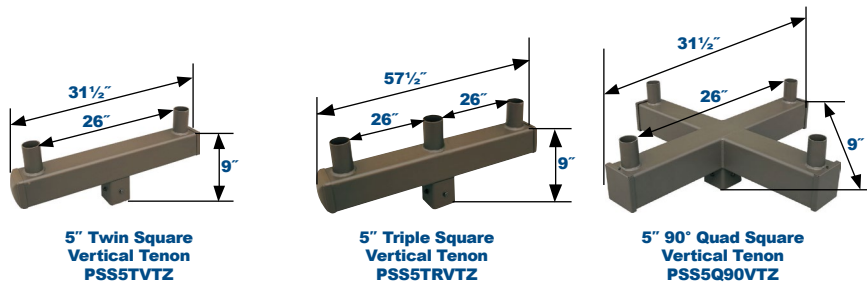

Vertical Tenon Pole Fitter:

Bronze Finish

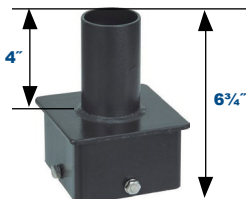

5" Single Square Vertical Tenon
PSS5SVTZ

Horizontal Tenon Pole Fitters:

4" Tenons, Bronze Finish

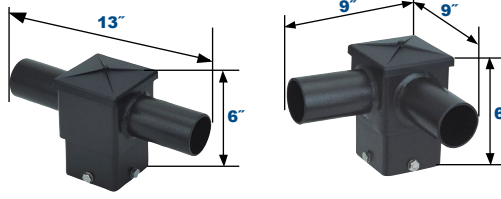

5" 180° Twin Square Horizontal Tenon
PSS5T180HTZ

5" 90° Twin Square Horizontal Tenon
PSS5T90HTZ

Wall Mounting Bracket:

Bronze Finish

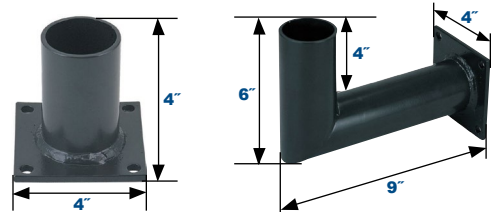

Wall Mount Bracket
PRSWMBZ

Wall Mount 90° Bracket
PRSWMB90Z

Replacement Parts:



Replacement Parts
(Order separately, Field installed)

PSS5CZ	5" Polycarbonate Pole Cap
PSS5CVRZ	Base Cover, Bronze Finish
PAB1X36	M22 x 33" Anchor Bolts, Set of 4
PSSHHC	Hand Hole Cover, Bronze Finish

Specifications subject to change without notice. Rev. 073117