

EasyLED Series

Bentley Large Area/Roadway IP67



ST35Q

Housing:

Heavy-Duty Low Profile Die Cast Housing with Integral Heat Sinking, Driver Compartment, Mounting Arm Adaptor. Powdercoat Finish Over a Chromate Conversion Coating. Includes Twist Lock Photocell Receptacle.

Lens:

Tempered Clear Flat Glass Lens or Tempered Clear Flat Prismatic Glass Lens

Mounting:

Mounts on 2 $\frac{3}{8}$ " Diameter Mounting Arm, Adjustable Slipfitter, or Two-Piece Swivel Bracket.

LumaFit LED:

Array Lumens: 34,739 (C Optic); 38,089 (F Optic)
Delivered Lumens: 29,091 (C, Clear);
32,884 (F, Clear);
28,415 (F, Prismatic)

CRI: 86

CCT: 4000K, 5000K

Rated Life: 50,000 Hours

5-Year Warranty

Aluminum Boards

Wattage:

Array: 278.8w, System: 301.3w

Driver:

Electronic Driver, 120-277V, 50/60Hz or
347/480V, 50/60Hz;

Dimmable Driver

Listing & Ratings:

CSA: Listed for Wet Locations. IP67

Operating Temperatures: -40°C to +50°C

LM-79 Report Available on Select Models.

Options:

Surge Protection

Custom Colors Available Upon Request.

KELSEY-KANE LIGHTING MFG. CO.

Voice & Text: 954-772-3187

E-Mail: info@kelsey-kane.com

Website: www.kelsey-kane.com



DesignLights Consortium™ Qualified Luminaires:
ST35QC1X279U5KC**
ST35QF1X279U5KC**

Bentley Large Area/Roadway

Catalog #

Description

Complete Units

Ordering Information

Example: ST35QF1X279U5KCZMASP

ST35	Model:	ST35
Q	LED Mfr:	Q=QSSI
F	Optics:	A=Type I, B=Type II, C=Type III, F=Type V
1X	Number of Arrays:	1X=One
279	Wattage:	279=279w
U	Ballast:	U=120-277V, H=347/480V
5K	CCT:	4K=4000K, 5K=5000K
C	Lens:	C=Tempered Clear Flat Glass Lens, P=Tempered Clear Flat Prismatic Glass Lens* *Use with F Optic Only.
Z	Color:	Z=Bronze
MA	Mounting:	BR=Two-Piece Swivel Bracket, SF=Slipfitter, MA=Mounting Arm Adapter
SP	Options:	R7=7-Pin ANSI C136.41-2013 Twist Lock Receptacle, SF=Single Fuse, DF=Double Fuse, SP=Surge Protection P40=P18140 110-120VAC Instant, P42=P18142 110-277VAC Instant, P50=P18150 120VAC Time Delay, P52=P18152 277VAC Time Delay



DIMENSIONS

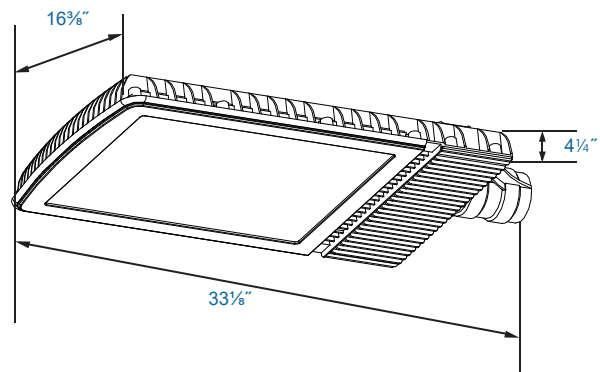

ST35Q

Catalog #	Description
ST35GLP	Tempered Clear Flat Prismatic Glass Lens
ST35GSZ	Aluminum House Side Shield, Bronze Powdercoat Finish, Includes Hardware.
ST35WG	Wire Guard, Stainless Steel Construction
STSFZ	Adjustable Die Cast Double Slipfitter with Angle Indicators Allows Mounting on Vertical Tenons, Includes Hardware. Bronze Finish.
CVMAZ	Die-Cast Adaptor for 2 3/8" Horizontal Mounting Arms, Bronze Powdercoat Finish, Includes Hardware.
FL90BRZ	Two-Piece Stamped Steel Adjustable Bracket, Bronze Powdercoat Finish, Includes Hardware.
FL90SFZX	External Mount Die-Cast Adjustable Slipfitter for 2 3/8" Tenons, Bronze Powdercoat Finish, Includes Hardware.
PSS4T180HTZ	4" 180° Twin Square Horizontal Tenon, Bronze Finish
PSS5T180HTZ	5" 180° Twin Square Horizontal Tenon, Bronze Finish
PTSB1SZ	Single Pole Tenon Spoke Bracket, 2 3/8" Horizontal Mounting Arm, Bronze Powdercoat Finish, Includes Hardware.
PTSB290SZ	Twin Pole Tenon Spoke Bracket, 2 3/8" Horizontal 90° Mounting Arms, Bronze Powdercoat Finish, Includes Hardware.
PTSB2180SZ	Twin Pole Tenon Spoke Bracket, 2 3/8" Horizontal 180° Mounting Arms, Bronze Powdercoat Finish, Includes Hardware.
PTSB390SZ*	Triple Pole Tenon Spoke Bracket, 2 3/8" Horizontal 90° Mounting Arms, Bronze Powdercoat Finish, Includes Hardware.
PTSB3120SZ*	Triple Pole Tenon Spoke Bracket, 2 3/8" Horizontal 120° Mounting Arms, Bronze Powdercoat Finish, Includes Hardware
PTSB490SZ*	Quad Pole Tenon Spoke Bracket, 2 3/8" Horizontal 90° Mounting Arms, Bronze Powdercoat Finish, Includes Hardware.
P18130	480VAC Twist Lock Photocell Receptacle
P18130R7	7-Pin Twist Lock Photocell Receptacle ANSI C136.41-2013 with Integrated Controls for LED, 480 VAC
P18131	Twist Lock Non-Shorting (Open) Cap Disconnects Service to Fixture for Temporary or Permanent Disabling (Fixture Always Off). IP65, 480V Maximum.
P18132	Twist Lock Shorting Cap Provides Fixed Service to Fixture (Fixture Always on). IP65, Rated Load 7200w Tungsten.
P18140	110-120VAC Instant Twist Lock
P18142	110-277VAC Instant Twist Lock
P18150	120VAC Time Delay Twist Lock
P18152	277VAC Time Delay Twist Lock

*Special order item. Lead time three weeks.

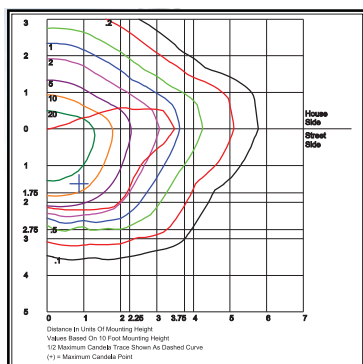

ST35QC1X279U5KC

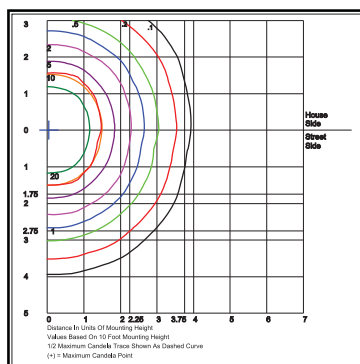

ST35QF1X279U5KC

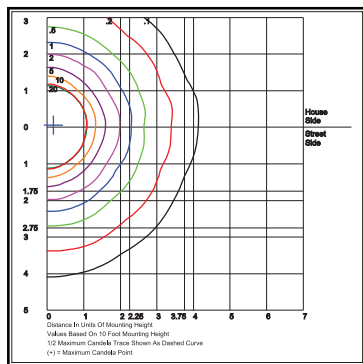

ST35QF1X279U5KP

PHOTOMETRICS

EasyLED Series

Bentley Large Area/Roadway

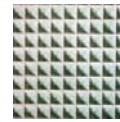

ST35GLP



ST35GSZ

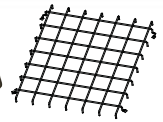

ST35WG



STSFZ
(Shown Mounted)



CVMAZ
(Shown Mounted)



FL90BRZ



FL90SFZX



PSS4T180HTZ,
PSS5T180HTZ



PTSB1SZ



PTSB290SZ



PTSB2180SZ



PTSB390SZ*



PTSB3120SZ*



PTSB490SZ*



P18130



P18130R7



P18131



P18132



P18140,
P18142



P18150
P18152

KELSEY-KANE LIGHTING MFG. CO.
 Voice & Text: 954-772-3187
 E-Mail: info@kelsey-kane.com
 Website: www.kelsey-kane.com

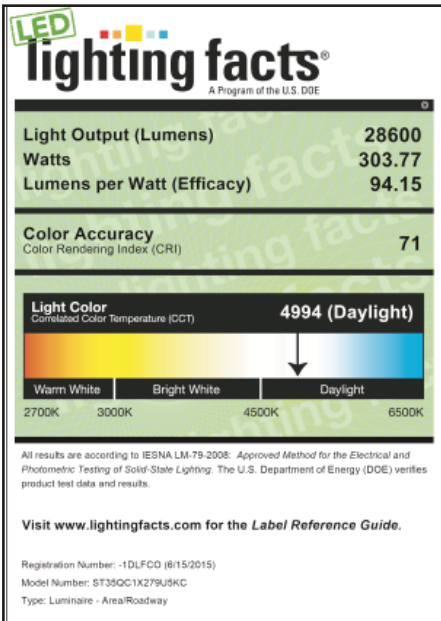

*LM-79 Report Available.
DesignLights Consortium™ Qualified Luminaire.*

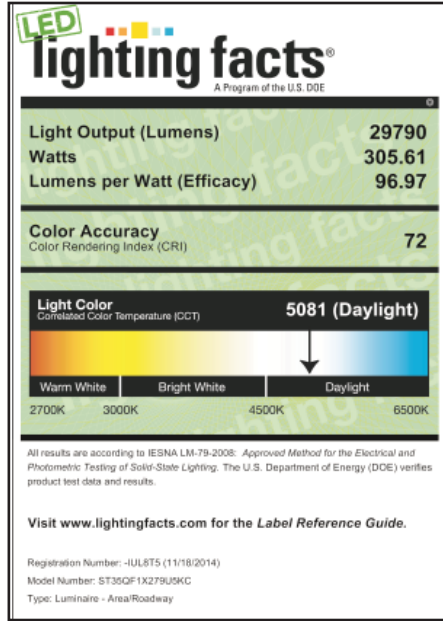

*LM-79 Report Available.
DesignLights Consortium™ Qualified Luminaire.*

KELSEY-KANE LIGHTING MFG. CO.
Voice & Text: 954-772-3187
E-Mail: info@kelsey-kane.com
Website: www.kelsey-kane.com